

»» Features

- Mini ISO high power automotive relay 30A/50A.
- High temperature endurance up to 125 degree C.
- Optional SPNC, SPNO, SPDT, DPNO contact configurations.
- Optional to be equipped with protection diode or resistor.
- Both available PCB terminal and quick connect terminal versions.
- Available for plain cover type, skirted cover flanged cover, and weather proof versions.
- Tinned terminal is available on request.
- Comply with RoHS-Directive 2002/95/EC, and ELV-Directive 2000/53/EC.

»» Type List

Terminal style	Contact form	Enclosure style		
		Dust cover	Flux tight	Sealed type washable
Socket terminal	1A (SPNO)	896-1AH-D	896-1AH-C	896-1AH-S
		896H-1AH-D	896H-1AH-C	896H-1AH-S
	1C (SPDT)	896-1CH-D	896-1CH-C	896-1CH-S
		896H-1CH-D	896H-1CH-C	896H-1CH-S
	2A (DPNO)	896-2AH-D	896-2AH-C	896-2AH-S
		896H-2AH-D	896H-2AH-C	896H-2AH-S
PCB terminal	1A (SPNO)	896P-1AH-D	896P-1AH-C	896P-1AH-S
		896HP-1AH-D	896HP-1AH-C	896HP-1AH-S
	1C (SPDT)	896P-1CH-D	896P-1CH-C	896P-1CH-S
		896HP-1CH-D	896HP-1CH-C	896HP-1CH-S
	2A (DPNO)	896P-2AH-D	896P-2AH-C	896P-2AH-S
		896HP-2AH-D	896HP-2AH-C	896HP-2AH-S

Terminal style	Contact form	Enclosure style	
		Flanged cover (dust cover)	Flanged cover (flux tight)
Socket terminal	1A (SPNO)	896-1AH-D1	896-1AH-C1
		896H-1AH-D1	896H-1AH-C1
	1C (SPDT)	896-1CH-D1	896-1CH-C1
		896H-1CH-D1	896H-1CH-C1
	2A (DPNO)	896-2AH-D1	896-2AH-C1
		896H-2AH-D1	896H-2AH-C1

Terminal style	Contact form	Enclosure style	
		Steel bracket (dust cover)	Steel bracket (flux tight)
Socket terminal	1A (SPNO)	896-1AH-D1S	896-1AH-C1S
		896H-1AH-D1S	896H-1AH-C1S
	1C (SPDT)	896-1CH-D1S	896-1CH-C1S
		896H-1CH-D1S	896H-1CH-C1S
	2A (DPNO)	896-2AH-D1S	896-2AH-C1S
		896H-2AH-D1S	896H-2AH-C1S

Terminal style	Contact form	Designation (provided with)	Enclosure style	
			Steel bracket (dust cover with shroud)	Steel bracket (dust cover with weather proof)
Socket terminal	1C (SPDT)	Resistor	896H-1CH-D1SF-R1	896H-1CH-D1SW-R1

»» Ordering Information

896 □ □ - 1AH - C - □ - □ □
 1 2 3 4 5 6 7 8

- | | |
|---|---|
| 1. 896 -- Basic series designation | D1S -- Steel bracket (dust cover) |
| 2. Blank -- Standard type | C1S -- Steel bracket (flux tight) |
| H -- High power type | S1S -- Steel bracket (sealed type washable) |
| 3. Blank -- Socket terminal | D1SF -- Steel bracket (dust cover with shroud) |
| P -- PCB terminal | D1SW -- Steel bracket (dust cover with weather proof) |
| 4. 1AH -- Single pole normally open, contact material AgSnO | 6. Blank -- Standard type |
| 1BH -- Single pole normally closed, contact material AgSnO | R1 -- Coil parallel with resistor 1/2W for 12V 680Ω , 24V 2700Ω |
| 1CH -- Single pole double throw, contact material AgSnO | 7. Blank -- Standard type |
| 2AH -- Double pole double make, contact material AgSnO | T -- Special requirement for Tin plated terminal |
| 5. D -- Dust cover | 8. Blank -- Standard type |
| C -- Flux tight | 001 -- Coil parallel with diode IN4007 the positive pole on # 85 terminal |
| S -- Sealed type washable | 002 -- Coil parallel with diode IN4007 the negative pole on # 85 terminal |
| C1 -- Flanged cover (flux tight) | |
| D1 -- Flanged cover (dust cover) | |
| S1 -- Flanged cover (sealed type washable) | |

»» Contact Rating

Type	896 1A	896 1B	896 1C	896 2A
Resistive load	40A 14VDC	40A 14VDC	NO : 40A 14VDC NC : 30A 14VDC	2×15A 14VDC

Type	896H 1A	896H 1B	896H 1C	896H 2A
Resistive load	50A 14VDC 20A 28VDC	40A 14VDC 15A 28VDC	NO : 50A 14VDC, 20A 28VDC NC : 30A 14VDC, 15A 28VDC	2×30A 14VDC 2×10A 28VDC

»» Coil Rating(DC)

Rated voltage (V)	Rated current ±10 % at 23°C (mA)	Coil resistance ±10 % at 23°C (Ω)	Max. continuous Voltage at 85°C ⁽¹⁾	Pick up voltage(Max) at 23°C	Drop out voltage(Min) at 23°C	Power consumption at rated voltage
12	133	90	120 % of rated voltage	65 % of rated voltage	10 % of rated voltage	approx. 1.6W
24	66.7	360				

Notes : (1) Without switching the load.

»» Specification

Contact material	AgSnO alloy	
Contact voltage drop ⁽¹⁾	Typ. 50mV at 10A	
Insulation resistance ⁽¹⁾	20MΩ Min. (DC 500V)	
Operate time ⁽¹⁾	20ms Max.	
Release time ⁽¹⁾	20ms Max.	
Dielectric strength ⁽¹⁾	Between open contact	: AC 500V , 50/60Hz 1 min.
	Between contact and coil	: AC 500V , 50/60Hz 1 min.
Vibration resistance	Operating extremes	10~500Hz , 5.0G
	Damage limits	10~500Hz , 5.0G
Shock resistance	Operating extremes	10G
	Damage limits	100G
Life expectancy	Mechanical	10,000,000 operations (frequency 18,000 operations/hr)
	Electrical	100,000 operations (frequency 1,200 operations/hr)
Temperature range	Operating	-40~+125°C (no freezing)
Weight	Approx. 40 g	

Note : (1) initial value

896

»» Outline Dimensions

◆ 896,896H (C,D,S)

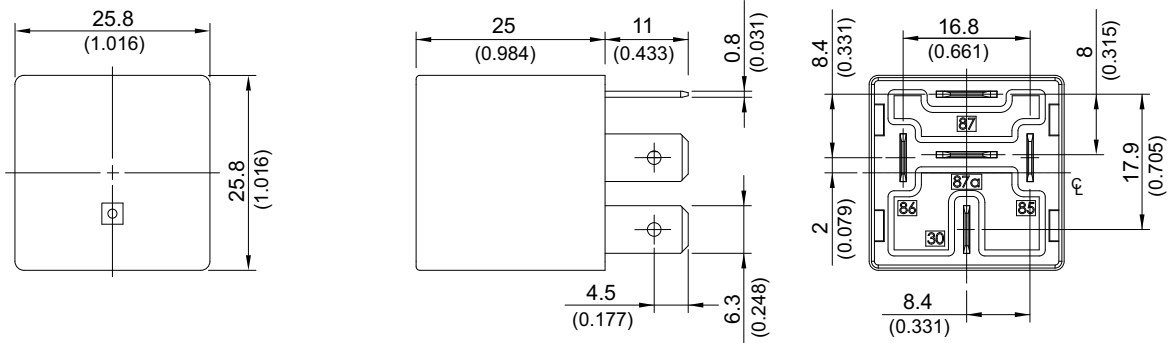

◆ 896,896H (C1,D1,S1)

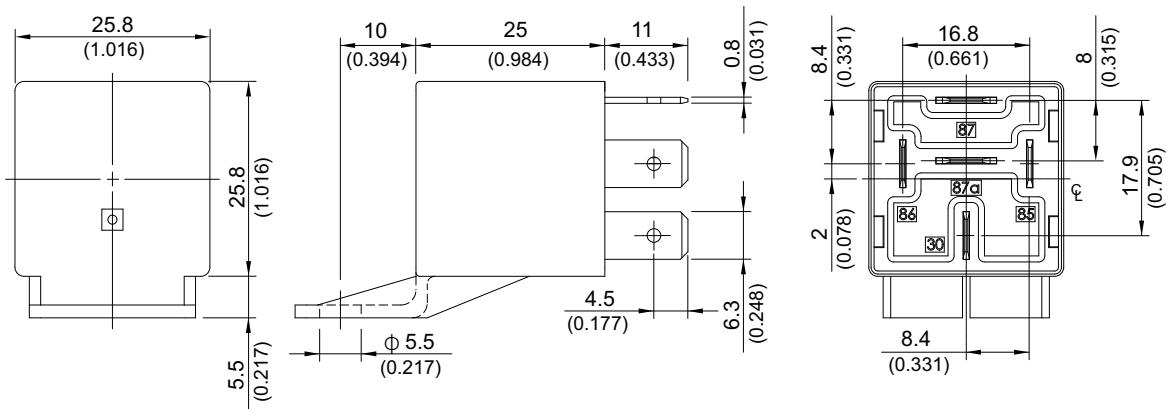

◆ 896,896H (C1S,D1S,S1S)

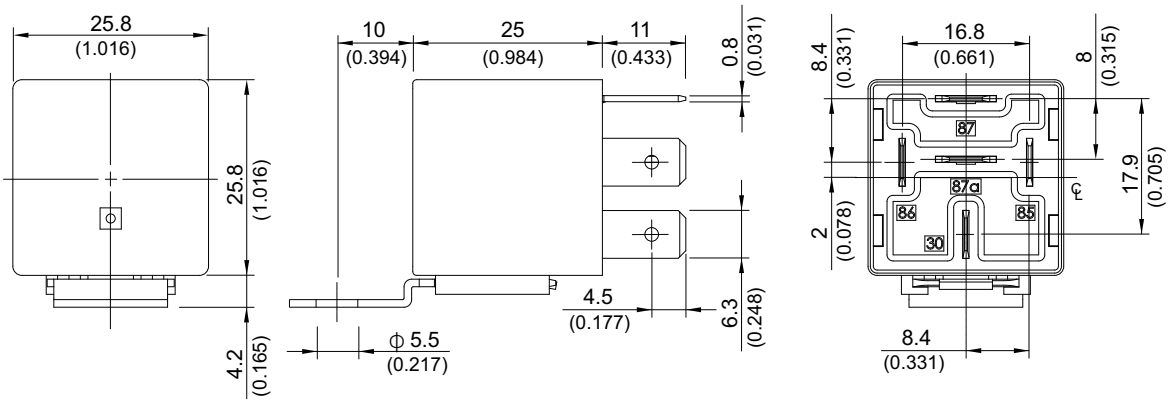

◆ 896P,896HP (C,D,S)

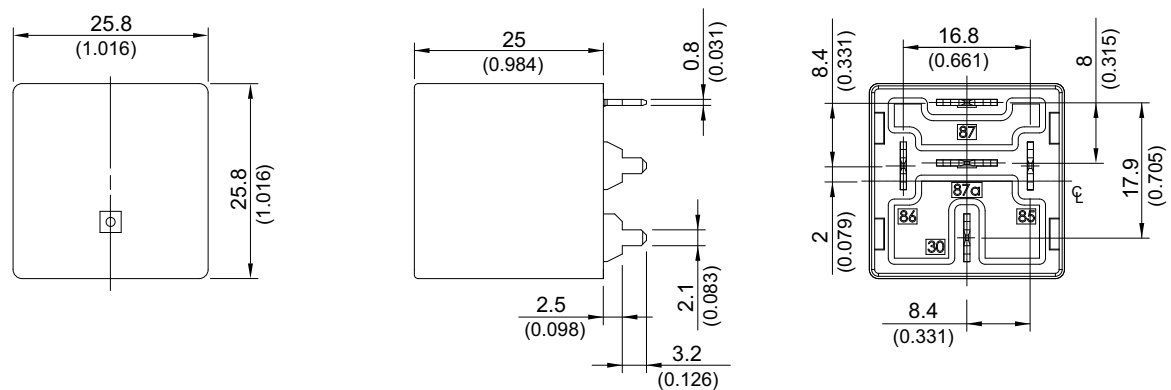

◆ 896H (D1SW)

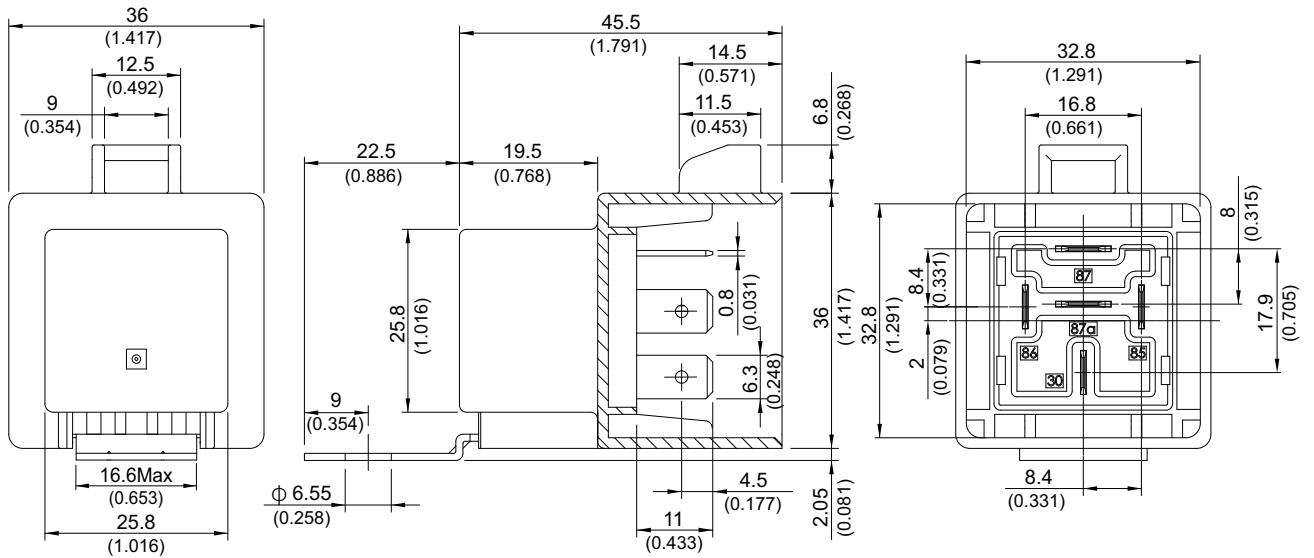

◆ 896H (D1SF)

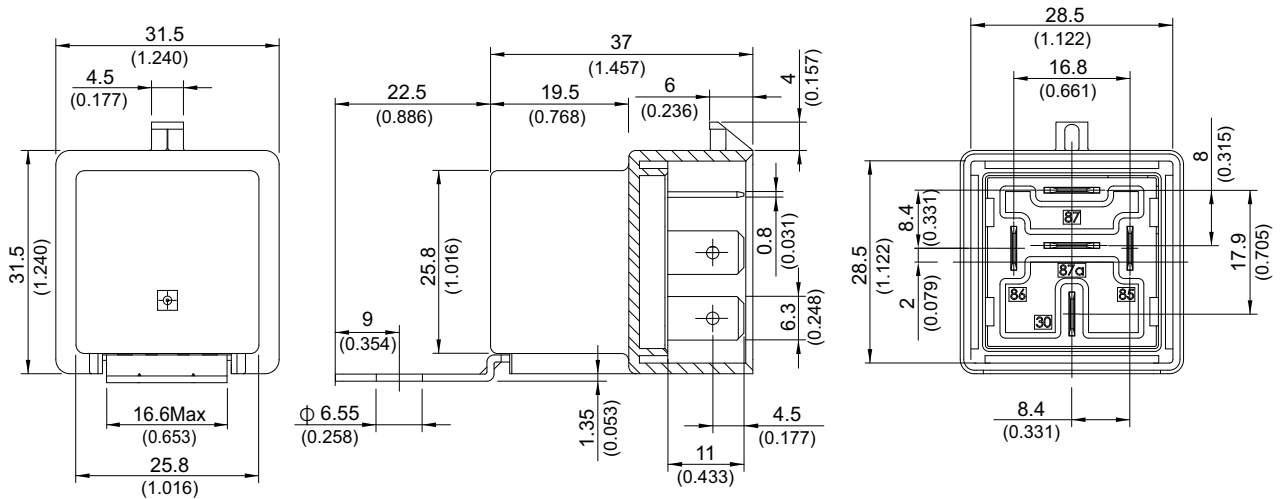

» Wiring Diagram

BOTTOM VIEW

>

1A

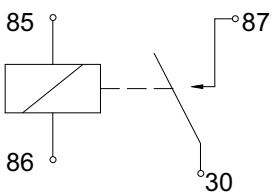

1B

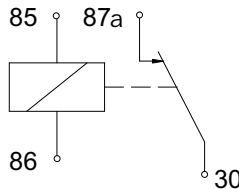

1C

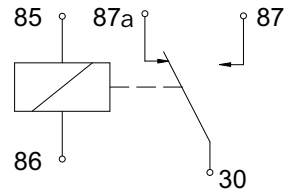

2A

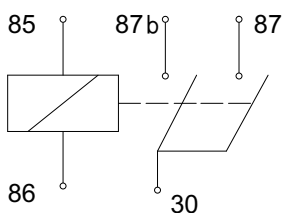

R1

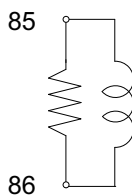

001

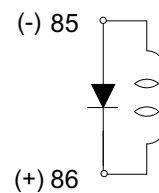

002

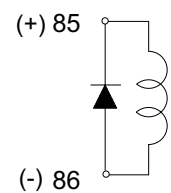

896

PC Board Layout BOTTOM VIEW

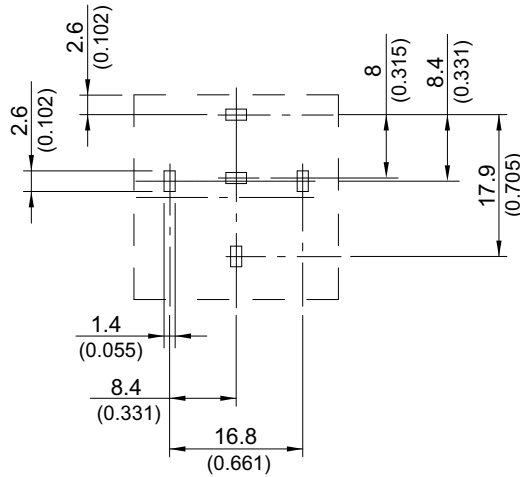

Engineering Data

